



NOMAD™

OPERATION MANUAL

PWR-FLO™

**NPF07 POLYPROPYLENE PUMP CLAMPED
PWR-FLO AIR DISTRIBUTION SYSTEM**



AIR-OPERATED  **DOUBLE DIAPHRAGM**  **PUMPS**





A JDA Global Company

Tel: 866-777-6060
Fax: 866-777-6383

Springer Pumps, LLC

Website: www.springerpumps.com
Int'l: +001 267 404 2910

 **CAUTION:** Do not apply compressed air to the exhaust port – pump will not function.

 **CAUTION:** Do not over-lubricate air supply – excess lubrication will reduce pump performance. Pump is pre-lubed.

 **TEMPERATURE LIMITS:**

Neoprene	-17.7°C to 93.3°C	0°F to 200°F
Buna-N	-12.2°C to 82.2°C	10°F to 180°F
EPDM	-15.1°C to 137.8°C	-60°F to 280°F

NOTE: Not all materials are available for all models. Refer to Section 2 for material options for your pump.

 **CAUTION:** Check temperature limits for all wetted components. Example: Viton® has a maximum limit of 176.7°C (350°F) but polypropylene has a maximum limit of only 79°C (175°F).

 **CAUTION:** Maximum temperature limit are based upon mechanical stress only. Certain chemicals will significantly reduce maximum safe operating temperatures.

 **WARNING:** Prevention of static parking – if static sparking occurs, fire or explosion could result. Pump, valves, and containers must be grounded to a proper grounding point when handling flammable fluids and whenever discharge of static electricity is a hazard.

 **CAUTION:** Do not exceed 8.6 bar (125psig) air supply pressure.

 **CAUTION:** The process fluid and cleaning fluids must be chemically compatible with all wetted pump components.

 **CAUTION:** Do not exceed 82°C (180°F) air inlet temperature.

 **CAUTION:** Pumps should be thoroughly flushed before installing into process lines.

 **CAUTION:** Always wear safety glasses when operating pump. If diaphragm rupture occurs, material being pumped may be forced out air exhaust.

 **CAUTION:** Before any maintenance or repair is attempted, the compressed air line to the pump should be disconnected and all air pressure allowed to bleed from pump. Disconnect all intake, discharge and air lines. Drain the pump by turning it upside down and allowing any fluid to flow into a suitable container.

 **CAUTION:** Blow out air line for 10 to 20 seconds before attaching to pump to make sure all pipeline debris is clear. Use an in-line air filter. A 5µ (micron) air filter is recommended.

NOTE: When installing PTFE diaphragms, it is important to tighten outer pistons simultaneously (turning in opposite directions) to ensure a tight fit. (See torque specifications.)

NOTE: Before starting disassembly, mark a line from each liquid chamber to its corresponding air chamber. This line will assist in proper alignment during reassembly.

 **CAUTION:** Tighten all hardware prior to installation.

How It Works - Pump

N O M A D™

The NOMAD diaphragm pump is an air-operated, positive displacement, self-priming pump. These drawings show flow pattern through the pump upon its initial stroke. It is assumed the pump has no fluid in it prior to its initial stroke.

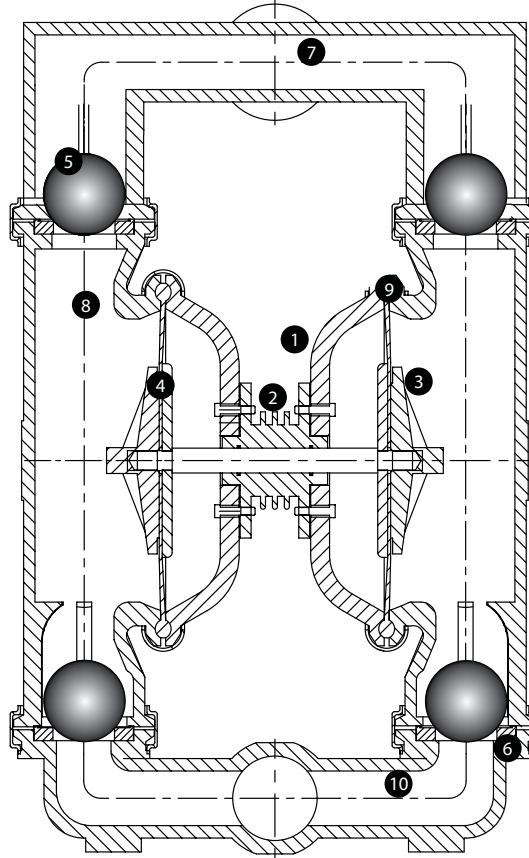

1. Air Chamber

The air chamber is the chamber that houses the air which powers the diaphragms.

2. Air Distribution System

The air distribution system is the heart of the pump. The air distribution system is the mechanism that shifts the pump in order to create suction and discharge strokes.

3. Lock Nut (Outer Diaphragm Piston)

The outer diaphragm pistons provide a means to connect the diaphragms to the reciprocating common shaft and to seal the liquid side from the air side of the diaphragm.

4. Holding plate (Inner Diaphragm Piston)

The inner piston is located on the air side of the pump and does not come into contact with the process fluid.

5. Check Valve Ball

NOMAD air-operated pumps use suction and discharge check valves to produce directional flow of process fluid in the liquid chamber. The check valve balls seal and release on the check valve seats allowing for discharge and suction of process fluid to occur.

6. Check Valve Seat

The removable seats provide the ball valves a site to check.

7. Discharge Manifold

Process fluid exits the pump from the discharge port located on the discharge manifold at the top of the pump.

8. Liquid Chamber

The liquid chamber is filled with the process fluid during the suction stroke and is emptied during the discharge stroke. It is separated from the compressed air by the diaphragms.

9. Diaphragm

The diaphragm membrane provides for separation of the process fluid and the compressed air power source. To perform adequately, diaphragms should be of sufficient thickness and of appropriate material to prevent degradation or permeation in specific process fluid applications. TABLA offers a variety of diaphragm materials for your specific application requirements.

10. Inlet Manifold

Process fluid enters the pump from the intake port located on the inlet manifold at the bottom of the pump.

Troubleshooting

Pump will not run or runs slowly.

1. Ensure that the air inlet pressure is at least 0.4 Bar (5 psig) above start up pressure and that the differential pressure (the difference between air inlet and liquid discharge pressures) is not less than 0.7 Bar (10 psig).
2. Check air inlet filter for debris
3. Check for extreme air leakage (blow by) which would indicate worn seals/bores in the air valve.
4. Disassemble pump and check for obstructions in the air passageway.
5. Check for sticking ball check valves. If material being pumped is not compatible with pump, elastomer, swelling may occur. Replace ball check valves and seals with proper elastomers. Also, as the check valve balls wear out, they become smaller and can become stuck in the seats. In this case, replace balls and seats.
6. Check for broken inner piston which will cause the air valve spool to be unable to shift.
7. Remove plug from pilot spool exhaust.

Pump runs but little or no product flows.

1. Check for pump cavitation; slow pump speed down to allow thick material to flow into liquid chambers.
2. Verify that vacuum required to lift is not greater than the vapor pressure of the material being pumped (cavitation).
3. Check for sticking ball valves. If material being pumped is not compatible with pump elastomers, swelling may occur. Replace ball check valves and seats with proper elastomers. Also, as the check valve balls wear out, they become smaller and can become stuck in the seats. In this case, replace balls and seats.

Pump air valve freezes.

1. Check for excessive moisture in compressed air. Either install a dryer or hot air generator for compressed air. Alternatively, a coalescing filter may be used to remove the water from the compressed air in some applications.

Air bubbles in pump discharge.

1. Check for ruptured diaphragm.
2. Check tightness of outer pistons.
3. Check tightness of fasteners and integrity of o-rings and seals, especially at intake manifold.
4. Ensure pipe connections are airtight

Product comes out air exhaust.

1. Check for diaphragm rupture.
2. Check tightness of outer pistons to shaft.

INSTALLATION:

- Suction pipe equal to/greater than pump diameter (same for discharge)
- Tighten all fasteners before use
- Suction connection should be non-collapsible

AIR SUPPLY:

- Air line size must be large enough to create desired volume (see performance curve section)
- Do not exceed 8.6 BAR (125 PSIG)
- For best results, use 5 micron air filter
- Use lubricator with 5 wt. oil

PIPING:

- Remove as many turns/elbows as possible
- Piping should be supported
- Flexible hose will avoid stress on pump fitting
- Gate Valve should be used in applications involving flooded suction
- In positive suction head conditions, limit inlet pressure to 0.5 - 0.7 BAR (7 - 10 PSI). Premature diaphragm failure will take place above the parameters.

ALL NOMAD PUMPS ARE CAPABLE OF PASSING SOLIDS. A STRAINER SHOULD BE USED ON THE PUMP INTAKE TO ENSURE THAT THE PUMP'S RATED SOLIDS CAPACITY IS NOT EXCEEDED.

CAUTION: DO NOT EXCEED 8.6 BAR (125 PSIG) AIR SUPPLY PRESSURE.

This illustration is a generic representation of an air-operated double-diaphragm pump.

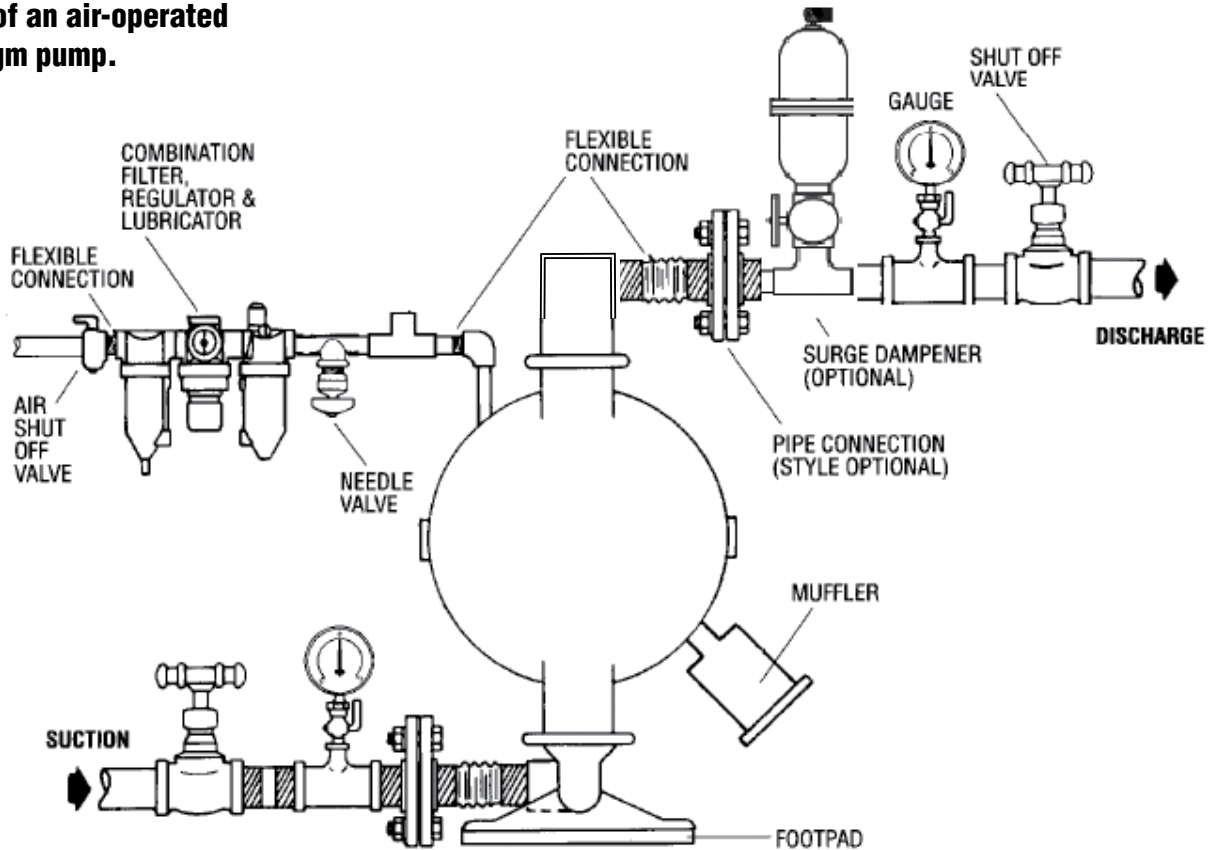

NOTE: In the event of a power failure, the shut off valve should be closed, if the restarting of the pump is not desirable once power is regained.

AIR OPERATED PUMPS: To stop the pump from operating in an emergency situation, simply shut off valve (user supplied) installed

in the air supply line. A properly functioning valve will stop the air supply to the pump, therefore stopping output. The shut off valve should be located far enough away from the pumping equipment such that it can be reached safely in an emergency situation.

How It Works - Pump



XXX XX / XXXX / XX / XX / XXX / X/X/X

1	2	3	4	5	6	7,8	9	10	11	12	13	ATEX
Air Distribution System	Liquid Port Size	Wetted Parts	Diaphragms & Valve Balls			Valve Seats	Fittings	Connections				
N Nomad	07 07mm/.25"	A Aluminum	BN Buna - N/ Nitrile	A Aluminum	N NPT	C Clamped						
T Trans-Flo	15 15mm/.5"	W Ductile	ND Nordel/EPDM	S Stainless Steel	B BSP	B Bolted						
TG Gold	25 25mm/1"	S Stainless Steel	NE Neoprene	BN Buna - N/Nitrile	TC Tri-Clamp							
PF Pwr-Flo	40 40mm/1.5"	P Polypropylene	TF PTFE (with Neoprene back-up)	NE Neoprene	FL Flanged							
DF Dura-Flo	50 50mm/2"	4 Air Chambers	VT Viton/FKM	ND Nordel/EPDM								
	80 80mm/3"	A Aluminum	FG Hytel®	VT Viton								
	100 100mm/4"	W Ductile	SN Santoprene®	SP Santoprene								
		S Stainless Steel	SNF Santoprene® - UFI	FG Hytel								
		W Mild Steel	TFF PTFE - UFI	P Polypropylene								
		P Polypropylene	TGN Garlock® - NEO BACKED	K Kynar								
		5 Center Block	TGE Garlock® - EPDM BACKED	PU Polyurethane								
		A Aluminum	TGV Garlock® - Viton BACKED	MTF Mild Steel								
		S Stainless Steel	PU Polyurethane	10 O-Ring								
		P Polypropylene	FGF Hytel UFI	BN Buna - N/Nitrile								
		6 Air Valve	PUF Polyurethane UFI	NE Neoprene								
		B Brass		ND Nordel/EPDM								
		P Polypropylene		VT Viton								
		A Aluminum		TF PTFE								
		S Stainless Steel		PU Polyurethane								
				SN Santoprene								
				PTV Viton Encap.								

NTG 50 / AAAB / TF / TF / ATF / N / C / X

1	2	3	4	5	6	7,8	9	10	11	12	13	ATEX
Air Distribution System	Liquid Port Size	Wetted Parts	Diaphragms & Valve Balls			Valve Seats	Fittings	Connections				
N Nomad	50 50mm/2"	A Aluminum	TF PTFE (with Buna back-up)	A Aluminum	N NPT	C Clamped						
T Trans-Flo		4 Air Chambers		10 O-Ring								
TG Gold		A Aluminum		TF PTFE								
PF Pwr-Flo		5 Center Block										
DF Dura-Flo		A Aluminum										
		6 Air Valve										
		B Brass										

**NPF07 POLY CLAMPED
PTFE-FITTED**

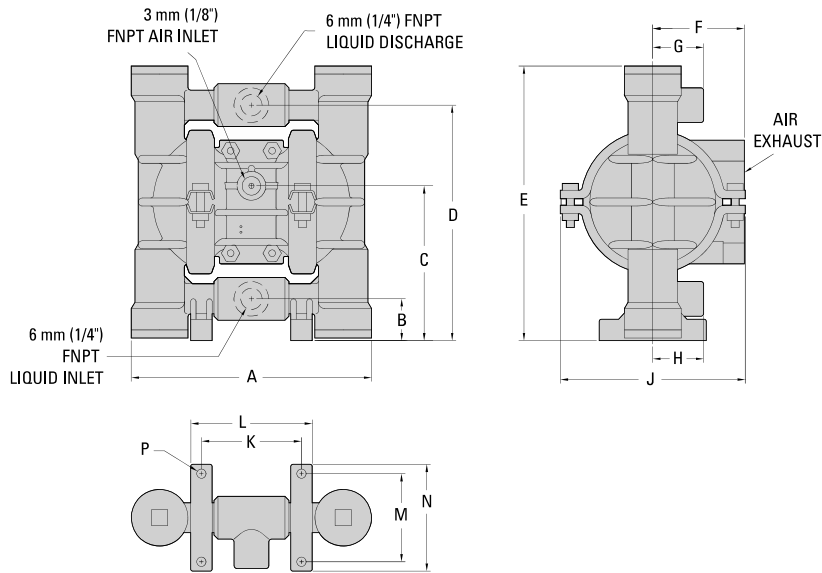

ITEM	METRIC (mm)	STANDARD (inch)
A	145	5.7
B	25	1.0
C	94	3.7
D	140	5.5
E	163	6.4
F	56	2.2
G	30	1.2
H	30	1.2
J	114	4.5
K	61	2.4
L	74	2.9
M	53	2.1
N	64	2.5
P	Ø5	Ø.2

NPF07 POLY CLAMPED RUBBER-FITTED

Est. Ship Weight.....Polypropylene 1.4 kg (3 lb)

Air Inlet.....3 mm (1/8")
 Inlet.....6 mm (1/4")
 Outlet.....6 mm (1/4")
 Suction Lift2.74 m Dry (9')
 9.45 m Wet (31')
 Disp. Per Stroke¹0.02 L (0.004 gal)
 Max. Flow Rate.....18.1 lpm (4.8 gpm)
 Max. Size Solids.....0.4 mm (1/64")

¹Displacement per stroke was calculated at 4.8 bar (70 psig) air inlet pressure against a 2 bar (30 psig) head pressure.

Example: To pump 7.6 lpm (2 gpm) against a discharge pressure head of 2 bar (30 psig) requires 4.1 bar (60 psig) and 2.0 Nm³/h (1.2 scfm) air consumption. (See dot on chart.)

Caution: Do not exceed 8.6 bar (125 psig) air supply pressure.

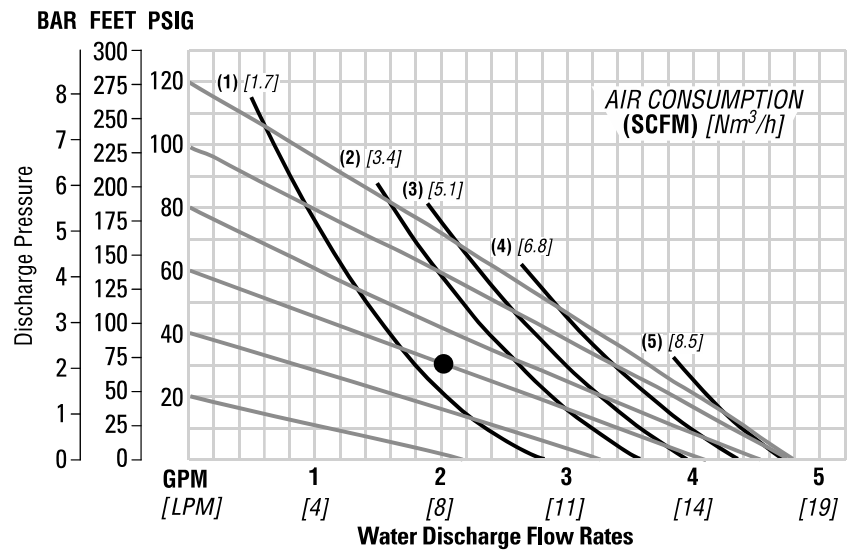

Flow rates indicated on chart were determined by pumping water.

For optimum life and performance, pumps should be specified so that daily operation parameters will fall in the center of the pump's performance curve.

NPF07 POLY CLAMPED TPE-FITTED

Est. Ship Weight.....Polypropylene 1.4 kg (3 lb)

Air Inlet.....3 mm (1/8")
 Inlet.....6 mm (1/4")
 Outlet.....6 mm (1/4")
 Suction Lift3.05 m Dry (10')
 8.84 m Wet (29')
 Disp. Per Stroke¹0.02 L (0.005 gal)
 Max. Flow Rate.....18.1 lpm (4.8 gpm)
 Max. Size Solids.....0.4 mm (1/64")

¹Displacement per stroke was calculated at 4.8 bar (70 psig) air inlet pressure against a 2 bar (30 psig) head pressure.

Example: To pump 7.6 lpm (2 gpm) against a discharge pressure head of 2 bar (30 psig) requires 4.1 bar (60 psig) and 2.0 Nm³/h (1.2 scfm) air consumption. (See dot on chart.)

Caution: Do not exceed 8.6 bar (125 psig) air supply pressure.

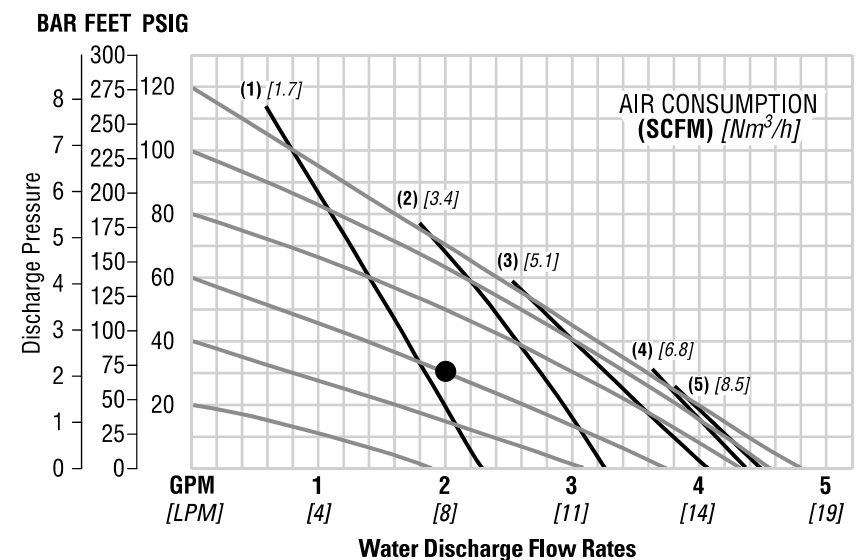

Flow rates indicated on chart were determined by pumping water.

For optimum life and performance, pumps should be specified so that daily operation parameters will fall in the center of the pump's performance curve.

Exploded View

NOMAD™

NPF07 RUBBER-TPE FITTED

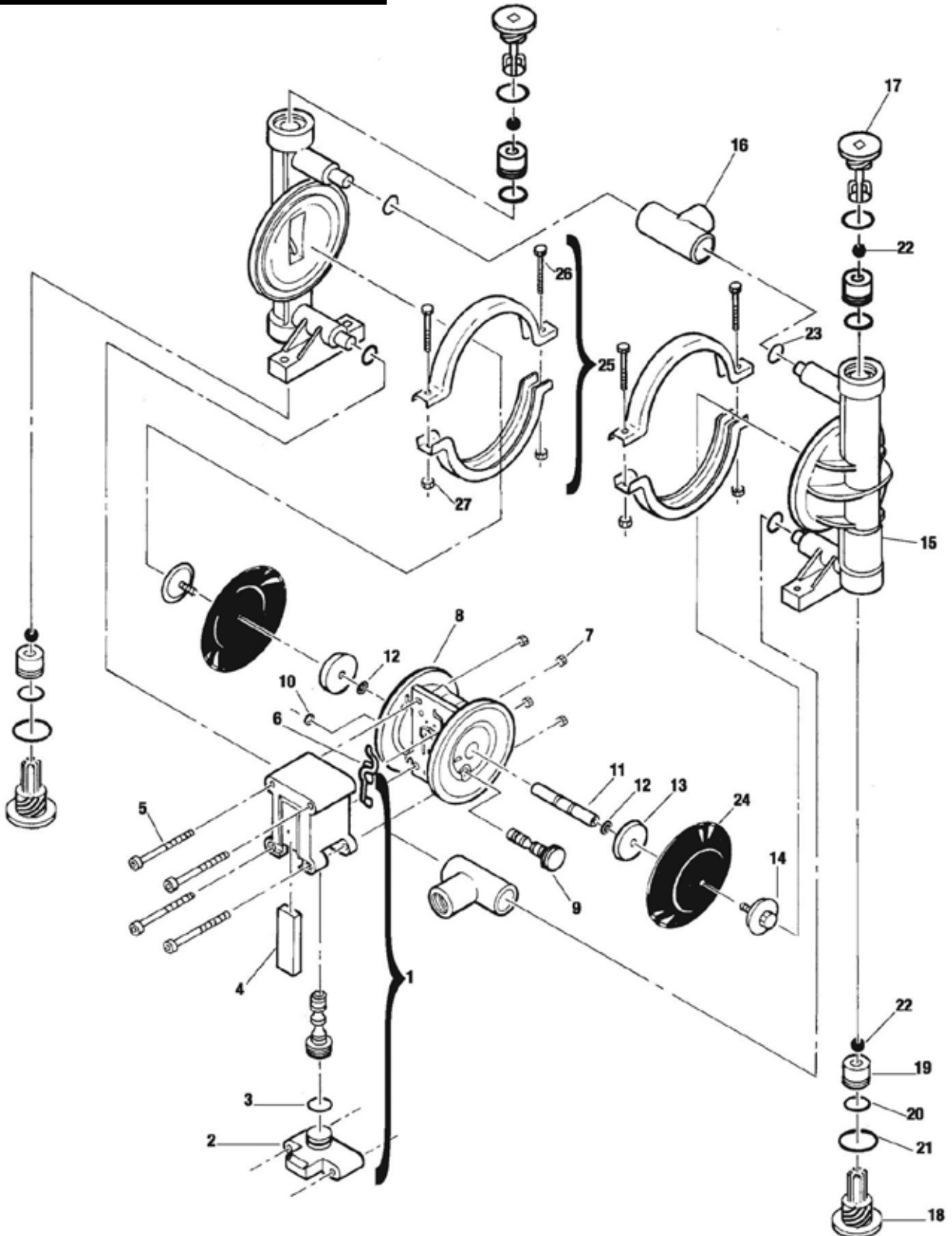

NPF07 RUBBER-TPE FITTED

No.	Part Description	Qty.	Part #
1	PWR-FLO® Air Valve Assembly	1	N00-2000-20-700
2	PWR-FLO® Air Valve End Cap	1	N00-2300-20-700
3	End Cap O-Ring (-017)	1	N00-2390-52-700
4	Muffler Element	1	N00-3240-26-700
5	Air Valve Bolt	4	N00-6000-03-700
6	Air Valve Gasket	1	N00-2600-52-700
7	Air Valve Nut	4	N01-6400-03
8	PWR-FLO® Center Section	1	N00-3150-20-700
9	Pilot Spool Assembly	1	N00-3850-99-700
10	Pilot Spool Retaining Ring	1	N00-2650-03-700
11	Shaft	1	N00-3800-99-700
12	Disc Spring	2	N00-6800-08
13	Inner Piston for Rubber/TPE	2	N00-3700-20-700
14	Outer Piston	2	N00-4570-20
15	Liquid Chamber	2	N00-5001-20
16	Manifold Tee Section	2	N00-5160-20
17	Top Retainer	2	N00-5411-20
18	Bottom Retainer	2	N00-5420-20
19	Valve Seat	4	N00-1130-20
20	Valve Seat O-Ring*	4	N00-1200-58
21	Combo Retainer O-Ring*	4	N00-1260-58
22	Valve Ball	4	N00-1080-55
23	Tee Section O-Ring*	4	N00-1300-58
24	Diaphragm*	2	N00-1010-58
25	Clamp Band Assembly	2	N00-7300-03
26	- Clamp Band Bolt	4	N01-6100-03
27	- Clamp Band Nut	4	N01-6400-03

*See Elastomer Options

¹Air Valve Assembly includes items 2, 3, and 4

Exploded View

N O M A D™

NPF07 PTFE FITTED

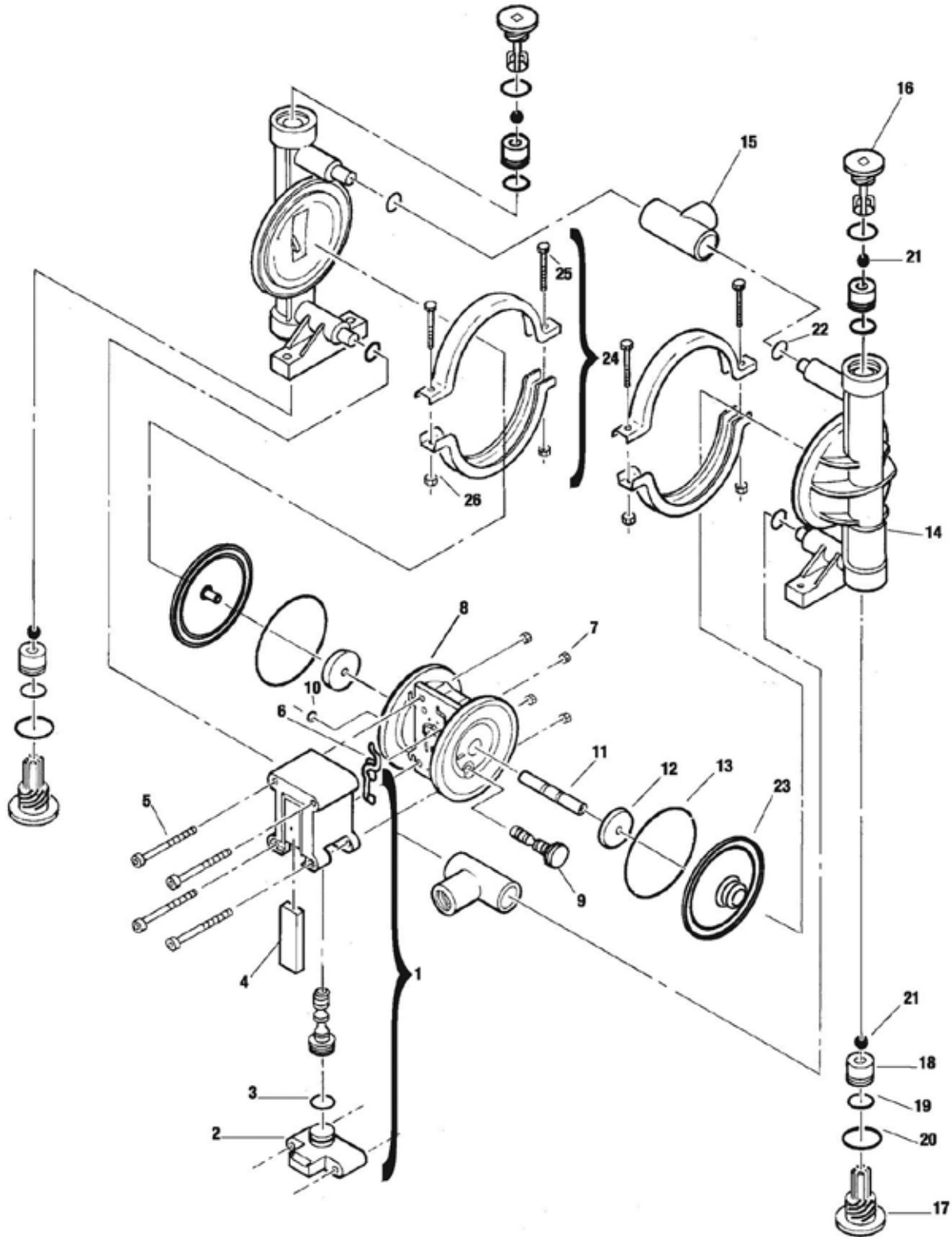

NPF07 PTFE FITTED

No.	Part Description	Qty.	Part #
1	PWR-FLO® Air Valve Assembly	1	N00-2000-20-700
2	PWR-FLO® Air Valve End Cap	1	N00-2300-20-700
3	End Cap O-Ring	1	N00-2390-52-700
4	Muffler Element	1	N00-3240-26-700
5	Air Valve Bolt	4	N00-6000-03-700
6	Air Valve Gasket	1	N00-2600-52-700
7	Air Valve Nut	4	N01-6400-03
8	PWR-FLO® Center Section	1	N00-3150-20-700
9	Pilot Spool Assembly	1	N00-3850-99-700
10	Pilot Spool Retaining Ring	1	N00-2650-03-700
11	Shaft	1	N00-3800-99-700
12	Rubber/TPE	2	N00-3700-20-700
13	Back Up O-Ring*	2	N00-1070-58
14	Liquid Chamber	2	N00-5001-20
15	Manifold Tee Section	2	N00-5160-20
16	Top Retainer	2	N00-5411-20
17	Bottom Retainer	2	N00-5420-20
18	Valve Seat	4	N00-1130-20
19	Valve Seat O-Ring*	4	N00-1206-60
20	Combo Retainer O-Ring*	4	N01-1205-60
21	Valve Ball	4	N00-1080-55
22	Tee Section O-Ring*	4	N00-1300-60
23	Diaphragm*	2	N00-1030-55
24	Clamp Band Assembly	2	N00-7300-03
25	- Clamp Band Bolt	4	N01-6100-03
26	- Clamp Band Nut	4	N01-6400-03

*See Elastomer Options

¹Air Valve Assembly includes items 2, 3, and 4



A JDA Global Company

1645 W. Park Ave., Suite 200
Redlands, CA USA 92373
(909) 798-9532

N O M A DTM



NO BOUNDARIESTM