



MFM220 & MFM220DC Plastic-Bodied Magmeter

APPLICATIONS

Usage monitoring, such as:

- Industrial wastewater discharge monitoring
- Cooling tower deduct metering
- Heap leach mining discharge monitoring
- Well monitoring
- Turf and landscape water monitoring
- Agriculture liquid monitoring

FEATURES

- Simple as a mechanical meter
- No moving parts
- Minimal straight pipe required
- Battery powered
- Built-in rate & total indicator
- Corrosion resistant

*** Will not read petroleum based liquids.**



Unobstructed Flow



150 Banjo Drive Crawfordsville, IN 47933
ph: 765-362-7367 fax: 800-458-0232
www.banjocorp.com

The 2" Flow Meter Series are a full-bore, plastic-bodied electromagnetic flow meter designed for flow and usage monitoring applications in 2" pipe. The polypropylene flow tube offers corrosion resistance to a wide range of chemicals. Its light weight and clamp flanges allow it to be easily installed or removed from the pipe for inspection. There are multiple configurations.

With no moving parts, the magmeter permits unobstructed flow, minimizing flow disturbances. The 2" Meter Series can be used in piping configurations where there is little space between the meter and valve. The 2" Meter Series, like other magmeters, are resistant to wear from debris. Since there are no bearings or propeller to wear out, downtime and maintenance are kept to a minimum. Because there are no mechanical parts in the flow stream, the meter tolerates high flows without damage. Please note that flow does not automatically turn the meter on.

The hinged, polyethylene cover protects from dust and UV rays, while permitting easy access to the LCD flow rate and total display. The electronics housing is made of rugged powder-coated die-cast aluminum. Flow rate and total can be displayed in a variety of units, customer-selected and factory-set.

The 2" Meter Series are used for tracking flow rates and total flow in usage monitoring applications. These would include wells, industrial wastewater, leach mining discharge, cooling tower deduct metering, turf and landscape applications, and other water reclamation operations. When changing the batteries, the 2" is designed to retain the internal settings and flow total.

The DC flow meters are externally powered via a 5-pin connector cable (20ft/6m) which also provides pulse output for use with a variety of displays and controls for remote reading, data logging, pulse-to-analog conversion, and telemetry applications.

The standard flow meters are a battery-operated unit for use when pulse output is not required. The batteries are user replaceable with an approximate 1-year life under continuous use, or more depending on the duty cycle. The flow meters shut off after 15 minutes of inactivity to preserve battery life.

Manual# FMM2000

Tel: 866-777-6060
Fax: 866-777-6383

Springer Pumps, LLC

Website: www.springerpumps.com
Int'l: +001 267 404 2910

INSTRUCTIONS

1. When placing the flowmeter in line, it is important to rotate the flowmeter so that it is approximately at a 45-degree angle. (See figure 1) This will improve performance of the flow meter. The flow meter can be placed vertical as long as flow is sufficient to fill the pipe.
2. **There are 3 photoeyes located on the face of the flow meter.**
Note: These are not buttons so you will not push them, instead, to activate you must hold your finger over the photoeye for 2-4 seconds. To reset the running total you must hold your finger over both the “batch reset” and the “batch/total” photoeyes. If you would like liters rather than gallons, you will need to hold your finger over the first and third photoeyes at the same time. (See figure 2)
3. There are six (6) AA batteries located inside the flow meter. To replace the batteries, simply remove the four cover bolts and gently remove the top cover. Replace batteries and fasten cover back in place. Be careful not to pinch any wires when assembling the cover. It is a good idea to change the batteries yearly.
4. The flow rate of the meter is designed to have an unlimited flow, meaning that the meter will read as much flow as one can push through a 2" full port coupling. However, the accuracy of the meter decreases as the meter reaches flows under 6 GPM. From 6 to 300 GPM the meter is within 2-3% accuracy.
5. Its advisable to thoroughly clean the meter and the electrodes at least once a year. This can be done by gently rubbing the electrodes with a piece of emery cloth.
6. The “EP” is an error message meaning that the system is idle and there is no fluid traveling through it at that time.
7. It is recommended to have at least 20 inches of straight pipe before the flow meter and at least 20 inches after.
8. The cover can be rotated. To rotate cover 90°, remove the 4 cover bolts and carefully rotate the cover to the desired position. Take note not to pull or pinch any of the connecting wires. To rotate the cover 180°, remove the 4 cover bolts, the 6 AA batteries and the 2 screws that hold the battery holder in place. Then rotate the battery holder and the cover together to the desired location. Take note not to pull or pinch any of the connecting wires.



FIGURE 1



FIGURE 2

FEATURES

Polyethylene protective cover

LCD rate and total indicator

Powder-coated die cast-aluminum electronics housing

Corrosion-resistant glass-filled polypropylene body

Lightweight for easy handling

DIMENSIONS

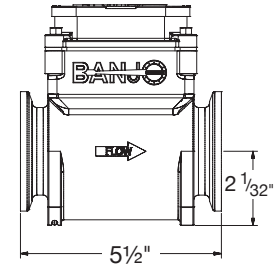
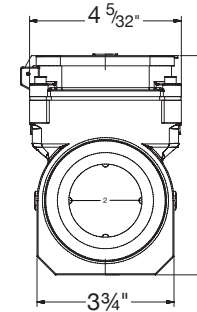

316 SS electrodes

Clamping flanges for ease of installation

3

SPECIFICATIONS*

SPECIFICATIONS		
Pipe Size		2" Full Port
Fittings		Flange Clamps
Pressure		150 PSI or 10.3 bar working pressure @ 70°F
Operating Temperature Range		10° to 130°F (-12° to 54°C)
Accuracy		+/-1% of reading from 100% to 10% of full scale
		+/-3% of reading from 10% to 10% of full scale to cut off => 2% to 10%
Flow Range	Minimum	6 gallons per minute (22.7 liters per second)
	Maximum	300 gallons per minute (1135.6 liters per second)
Materials	Body	Glass-filled polypropylene
	Electrodes	316 stainless steel
	Electronics Housing	Die cast aluminum, powder-coated
	Display Cover	Polyethylene
Display		Rate
	Digits	6
	Units	Gallons/Minute
		Liters/Minute
Power		6 AA alkaline cells, replaceable Life: 1 year with meter in use; 3 years dry
		10-30 Vdc @ 60 mA max (15 mA average) Note: Using an unregulated power supply >18 Vdc may damage the meter due to AC line input voltage fluctuation.
Pulse Output	Signal	Current sinking pulse, opto isolate, 32 Vdc max at 10 mA max
	Standard Pulse Rate	1 unit/pulse out, pulse width of 10 ms depending on unit selection
	High Frequency	30 Pulse per unit, pulse width 1.1 ms, min-max frequency, 3-150 HZ
Empty Pipe Detection		Hardware/software, conductivity-based
Conductivity		>20 microSiemens
Environmental		NEMA 4X standard; -40° to 176°F (-40° to 80° C) storage
Electrical Connection		5 pin male circular connector, mates to industry standard cable (20ft/6m)

* Specifications subject to change • Please consult our website for current data (www.banjocorp.com)

INSTALLATION

Piping Conditions

Installing the meter with a length of straight pipe at least two times the diameter upstream and one diameters downstream is highly recommended. Some piping conditions require more than this. See chart for recommendations.

If hose is used, use smooth bore hose.

Follow the diagram below to make the connections.

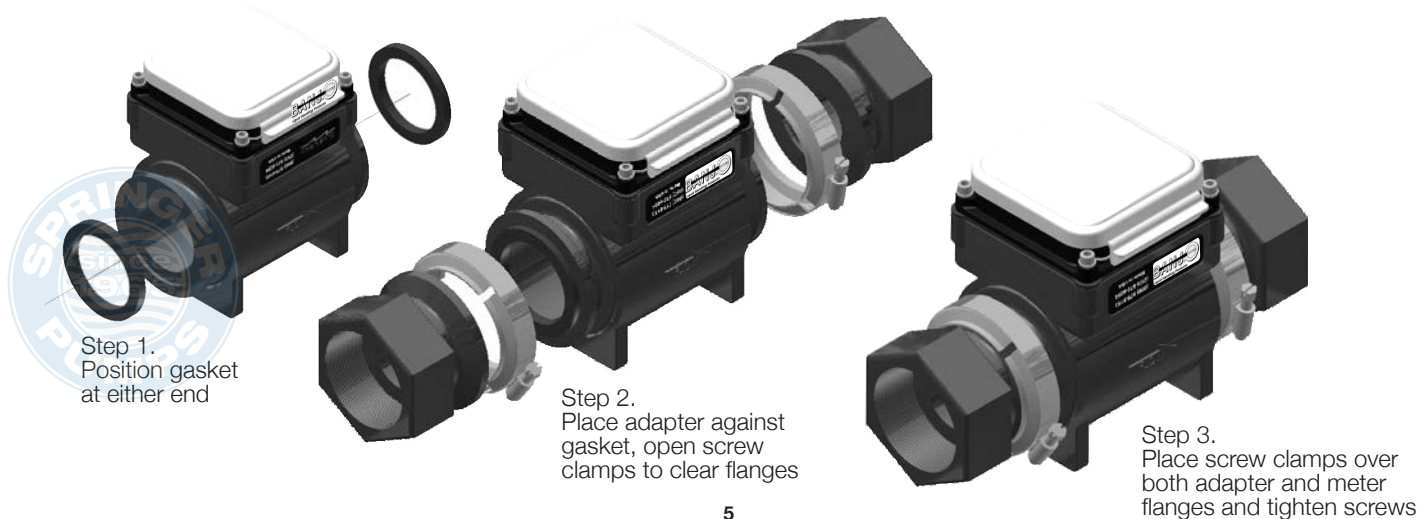

POSITION

This is an all position meter which can be installed either vertically or horizontally, register up, down or angled. However, entrained air or solids may make some positions preferable to others. See the position diagram for guidance.

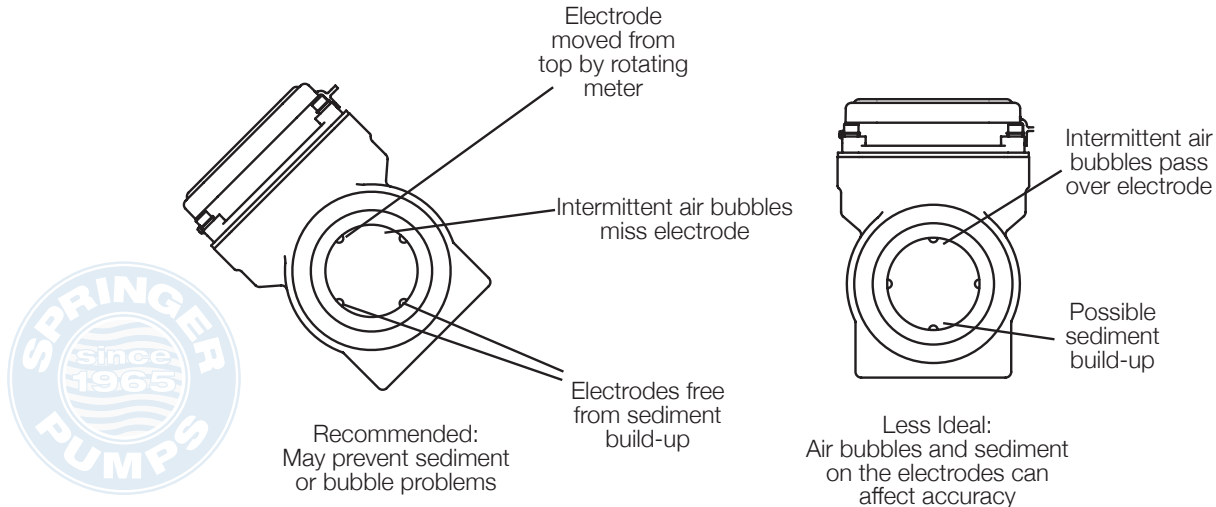

STRAIGHT AND FULL PIPE RECOMMENDATIONS

It is recommended to have at least 20 inches of straight pipe before the flow meter and at least 20 inches after.

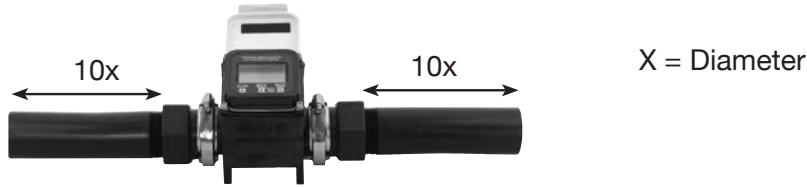

ELECTRICAL CONNECTIONS, CABLE CONNECTIONS & OPERATION

ELECTRICAL CONNECTIONS

A connector is provided on the outside of the flow meters. To connect to the meter, plug the cable in and hand tighten the retaining threads. Follow the diagram to make connections. If you are using the pulse output, connect power first and determine that the meter is working properly by observing the display, then connect the pulse output.

CABLE CONNECTIONS



Gray: Pin 5 = Ground
White: Pin 4 = (-) Pulse
Blue: Pin 3 = (+) Pulse
Black: Pin 2 = (-) Power
Brown: Pin 1 = (+) Power
Shield Drain Wire

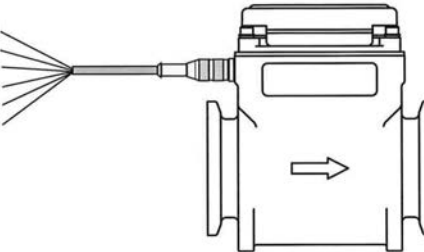

OPERATION - GROUNDING

For best performance, especially in noisy environments, the gray ground wire and the bare drain wire should be connected together and to a good earth ground as close to the meter as possible. Metal pipe and fittings in contact with the fluid, should also be bonded to the same earth ground with corrosion-resistant connections.

Display

The display reads flow rate and accumulated total, in the units for which it was ordered. The top line is total, the bottom line is rate, and indicators give the units (ac-ft, GPM for instance.) Empty or partially-full pipe is automatically detected and is indicated by a reading of “-EP-”.

Battery

Estimated battery life is approximately one year. Results may vary depending on the application. On the battery-powered 2" Series there are a low-battery indicator (“lo bat”) when the battery voltage drops below a certain point. Batteries should be changed within four weeks of the appearance of this indicator.

MAINTENANCE, REPAIR AND TROUBLE SHOOTING

MAINTENANCE AND REPAIR

There are no user-serviceable parts in the 2" Series meters except the batteries.

Battery Replacement

When the “Lo Batt” indicator appears, the batteries should be changed. Six alkaline AA cells are required. To change the batteries, first remove the four screws which hold the top cover in place. Be careful not to lose the washers. Move the top cover to one side and remove the foam retainer which covers the battery tray. Remove the old batteries and replace them with fresh ones, taking care to follow the polarity indicators in the battery tray. Replace the foam retainer, then put the top cover back in place. Put the four screws with washers back and tighten them firmly.

TROUBLE SHOOTING

PROBLEM

Blank Display

Reading “-EP-”

Flow but no flow rate reading

PROBABLE CAUSE

Batteries dead or misinstalled

Empty or partly filled pipe
Excessive air pockets or foaming

Heavily coated electrodes

TRY

Check polarity, replace batteries

Rearrange piping to ensure full pipe

Remove meter and wipe electrodes



Liquid Handling Products

150 Banjo Drive Crawfordsville, IN 47933
ph: 765-362-7367 fax: 800-458-0232
www.banjocorp.com

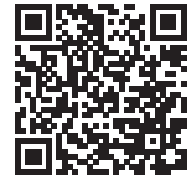

Scan this QR code to watch
our video on Flow Meters!



MFM220 & MFM220DC Plastic-Bodied Magmeter

APPLICATIONS

Usage monitoring, such as:

- Industrial wastewater discharge monitoring
- Cooling tower deduct metering
- Heap leach mining discharge monitoring
- Well monitoring
- Turf and landscape water monitoring
- Agriculture liquid monitoring

FEATURES

- Simple as a mechanical meter
- No moving parts
- Minimal straight pipe required
- Battery powered
- Built-in rate & total indicator
- Corrosion resistant

*** Will not read petroleum based liquids.**



Unobstructed Flow

150 Banjo Drive Crawfordsville, IN 47933
ph: 765-362-7367 fax: 800-458-0232
www.banjocorp.com



The 2" Flow Meter Series are a full-bore, plastic-bodied electromagnetic flow meter designed for flow and usage monitoring applications in 2" pipe. The polypropylene flow tube offers corrosion resistance to a wide range of chemicals. Its light weight and clamp flanges allow it to be easily installed or removed from the pipe for inspection. There are multiple configurations.

With no moving parts, the magmeter permits unobstructed flow, minimizing flow disturbances. The 2" Meter Series can be used in piping configurations where there is little space between the meter and valve. The 2" Meter Series, like other magmeters, are resistant to wear from debris. Since there are no bearings or propeller to wear out, downtime and maintenance are kept to a minimum. Because there are no mechanical parts in the flow stream, the meter tolerates high flows without damage. Please note that flow does not automatically turn the meter on.

The hinged, polyethylene cover protects from dust and UV rays, while permitting easy access to the LCD flow rate and total display. The electronics housing is made of rugged powder-coated die-cast aluminum. Flow rate and total can be displayed in a variety of units, customer-selected and factory-set.

The 2" Meter Series are used for tracking flow rates and total flow in usage monitoring applications. These would include wells, industrial wastewater, leach mining discharge, cooling tower deduct metering, turf and landscape applications, and other water reclamation operations. When changing the batteries, the 2" is designed to retain the internal settings and flow total.

The DC flow meters are externally powered via a 5-pin connector cable (20ft/6m) which also provides pulse output for use with a variety of displays and controls for remote reading, data logging, pulse-to-analog conversion, and telemetry applications.

The standard flow meters are a battery-operated unit for use when pulse output is not required. The batteries are user replaceable with an approximate 1-year life under continuous use, or more depending on the duty cycle. The flow meters shut off after 15 minutes of inactivity to preserve battery life.

Manual# FMM2000

Tel: 866-777-6060
Fax: 866-777-6383

Springer Pumps, LLC

Website: www.springerpumps.com
Int'l: +001 267 404 2910

INSTRUCTIONS

1. When placing the flowmeter in line, it is important to rotate the flowmeter so that it is approximately at a 45-degree angle. (See figure 1) This will improve performance of the flow meter. The flow meter can be placed vertical as long as flow is sufficient to fill the pipe.
2. **There are 3 photoeyes located on the face of the flow meter.**
Note: These are not buttons so you will not push them, instead, to activate you must hold your finger over the photoeye for 2-4 seconds. To reset the running total you must hold your finger over both the “batch reset” and the “batch/total” photoeyes. If you would like liters rather than gallons, you will need to hold your finger over the first and third photoeyes at the same time. (See figure 2)
3. There are six (6) AA batteries located inside the flow meter. To replace the batteries, simply remove the four cover bolts and gently remove the top cover. Replace batteries and fasten cover back in place. Be careful not to pinch any wires when assembling the cover. It is a good idea to change the batteries yearly.
4. The flow rate of the meter is designed to have an unlimited flow, meaning that the meter will read as much flow as one can push through a 2" full port coupling. However, the accuracy of the meter decreases as the meter reaches flows under 6 GPM. From 6 to 300 GPM the meter is within 2-3% accuracy.
5. Its advisable to thoroughly clean the meter and the electrodes at least once a year. This can be done by gently rubbing the electrodes with a piece of emery cloth.
6. The “EP” is an error message meaning that the system is idle and there is no fluid traveling through it at that time.
7. It is recommended to have at least 20 inches of straight pipe before the flow meter and at least 20 inches after.
8. The cover can be rotated. To rotate cover 90°, remove the 4 cover bolts and carefully rotate the cover to the desired position. Take note not to pull or pinch any of the connecting wires. To rotate the cover 180°, remove the 4 cover bolts, the 6 AA batteries and the 2 screws that hold the battery holder in place. Then rotate the battery holder and the cover together to the desired location. Take note not to pull or pinch any of the connecting wires.



FIGURE 1



FIGURE 2

STRAIGHT AND FULL PIPE RECOMMENDATIONS

It is recommended to have at least 20 inches of straight pipe before the flow meter and at least 20 inches after.

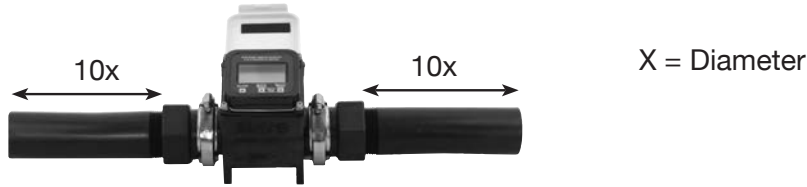

ELECTRICAL CONNECTIONS, CABLE CONNECTIONS & OPERATION

ELECTRICAL CONNECTIONS

A connector is provided on the outside of the flow meters. To connect to the meter, plug the cable in and hand tighten the retaining threads. Follow the diagram to make connections. If you are using the pulse output, connect power first and determine that the meter is working properly by observing the display, then connect the pulse output.

CABLE CONNECTIONS



Gray: Pin 5 = Ground
White: Pin 4 = (-) Pulse
Blue: Pin 3 = (+) Pulse
Black: Pin 2 = (-) Power
Brown: Pin 1 = (+) Power
Shield Drain Wire

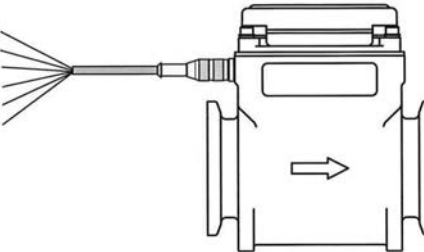

OPERATION - GROUNDING

For best performance, especially in noisy environments, the gray ground wire and the bare drain wire should be connected together and to a good earth ground as close to the meter as possible. Metal pipe and fittings in contact with the fluid, should also be bonded to the same earth ground with corrosion-resistant connections.

SPECIFICATIONS*

SPECIFICATIONS		
Pipe Size		2" Full Port
Fittings		Flange Clamps
Pressure		150 PSI or 10.3 bar working pressure @ 70°F
Operating Temperature Range		10° to 130°F (-12° to 54°C)
Accuracy		+/-1% of reading from 100% to 10% of full scale
		+/-3% of reading from 10% to 10% of full scale to cut off => 2% to 10%
Flow Range	Minimum	6 gallons per minute (22.7 liters per second)
	Maximum	300 gallons per minute (1135.6 liters per second)
Materials	Body	Glass-filled polypropylene
	Electrodes	316 stainless steel
	Electronics Housing	Die cast aluminum, powder-coated
	Display Cover	Polyethylene
Display		Rate
	Digits	6
	Units	Gallons/Minute
		Liters/Minute
Power		6 AA alkaline cells, replaceable Life: 1 year with meter in use; 3 years dry
		10-30 Vdc @ 60 mA max (15 mA average) Note: Using an unregulated power supply >18 Vdc may damage the meter due to AC line input voltage fluctuation.
Pulse Output	Signal	Current sinking pulse, opto isolate, 32 Vdc max at 10 mA max
	Standard Pulse Rate	1 unit/pulse out, pulse width of 10 ms depending on unit selection
	High Frequency	30 Pulse per unit, pulse width 1.1 ms, min-max frequency, 3-150 HZ
Empty Pipe Detection		Hardware/software, conductivity-based
Conductivity		>20 microSiemens
Environmental		NEMA 4X standard; -40° to 176°F (-40° to 80° C) storage
Electrical Connection		5 pin male circular connector, mates to industry standard cable (20ft/6m)

* Specifications subject to change • Please consult our website for current data (www.banjocorp.com)

INSTALLATION

Piping Conditions

Installing the meter with a length of straight pipe at least two times the diameter upstream and one diameters downstream is highly recommended. Some piping conditions require more than this. See chart for recommendations.

If hose is used, use smooth bore hose.

Follow the diagram below to make the connections.

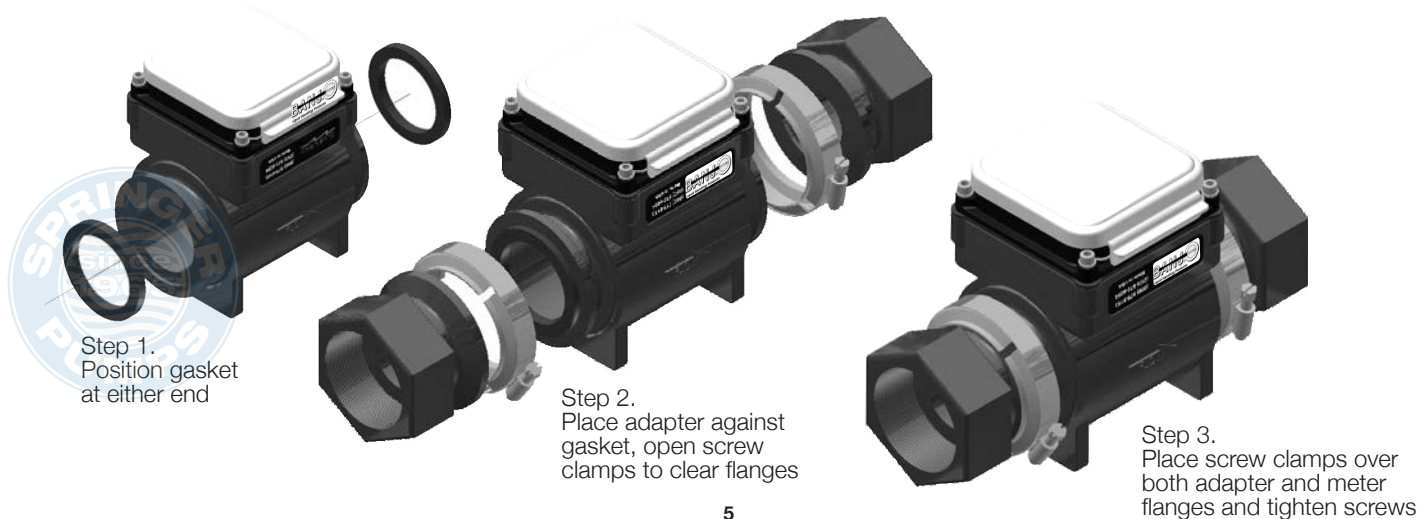

FEATURES

Polyethylene protective cover

LCD rate and total indicator

Powder-coated die cast-aluminum electronics housing

Corrosion-resistant glass-filled polypropylene body

Lightweight for easy handling

DIMENSIONS

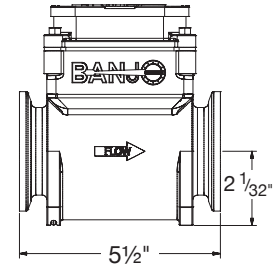
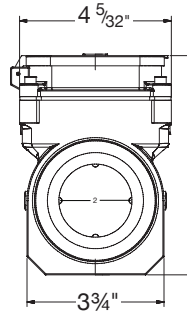

316 SS electrodes

Clamping flanges for ease of installation

3



POSITION

This is an all position meter which can be installed either vertically or horizontally, register up, down or angled. However, entrained air or solids may make some positions preferable to others. See the position diagram for guidance.

