

Please read and save this Repair Parts Manual. Read this manual and the General Operating Instructions carefully before attempting to assemble, install, operate or maintain the product described. Protect yourself and others by observing all safety information. The Safety Instructions are contained in the General Operating Instructions. Failure to comply with the safety instructions accompanying this product could result in personal injury and/or property damage! Retain instructions for future reference. AMT reserves the right to discontinue any model or change specifications at any time without incurring any obligation.

©2021 AMT Pump Company, A Subsidiary of The Gorman-Rupp Company, All Rights Reserved.

Periodic maintenance and inspection is required on all pumps to ensure proper operation. Unit must be clear of debris and sediment. Inspect for leaks and loose bolts. Failure to do so voids warranty.

# Solids Handling Pumps

## Cast Iron and Stainless Steel Models



Refer to pump manual 1808-634-00 for General Operating and Safety Instructions.

### DESCRIPTION

AMT High Head Solids Handling Centrifugal pumps are designed for pumping liquids containing up to 15% of volume and 1/8" maximum spherical diameter solids in continuous-duty OEM, Industrial/Commercial and processing applications including circulation, chemical processing, liquid transfer, and pressure boosting. All models feature cleanable stainless steel impellers capable of handling up to 1/8" spherical diameter solids and continuous duty, 3450 RPM, 56J frame motors. The discharge port on all models can be rotated in 90° increments to accommodate specific applications. Casing working pressure to 150 psi (1034 kPa). These are manual units, no controls are supplied. Single phase units are capacitor start and have automatic thermal protection. Check motor wiring before putting unit into operation (see motor nameplate for specific wiring diagrams). All units are for use with nonflammable liquids compatible with pump component materials.

### CAST IRON UNITS (-95)

Pump construction is cast iron casing and adapter with a stainless steel impeller. Viton type 21 mechanical shaft seal with silicon carbide wear faces. O-ring casing seal. Handles liquids from 40° to 180° F (4° to 82° C).

### STAINLESS STEEL UNITS (-98)

Pump construction is cast 300 series stainless steel casing, seal plate and impeller. Cast iron motor adapter. Viton type 21 mechanical shaft seal with silicon carbide wear faces. O-ring casing seal. Handles liquids from 40° to 200° F (4° to 93° C).

### MAINTENANCE

#### ▲ WARNING

*Make certain that the unit is disconnected from the power source before attempting to service or remove any components!*

### SHAFT SEAL REPLACEMENT

Refer to Figure 1.

### REMOVAL OF OLD SEAL

**IMPORTANT:** Always replace both seal seat (Ref. No. 14) and seal head (Ref. No. 13) to ensure proper mating of components!

1. Remove fasteners (Ref. No. 12) connecting casing (Ref. No. 10) to adapter (Ref. No. 2).
2. Remove casing.

#### ▲ CAUTION

*Care should be taken not to pinch or "shave" casing seal (Ref. No. 15) between adapter and casing.*

3. Use a box and/or socket wrench to remove impeller lock nut (Ref. No. 8). Remove impeller assembly (Ref. No. 5).

**NOTE:** Motor shaft must be held in place to remove impeller. Back of the motor either has slot in shaft (use large screwdriver to hold) or has 2 flats on motor shaft (use 7/16 open end wrench to hold). Impeller and impeller fastener unscrew CCW (Counter Clockwise) when looking at the front of pump.

**IMPORTANT:** Care should be taken to be sure that the same number of thickness of shim washers (Ref. No. 9) are replaced behind the impeller as was removed. Shim washers are located directly behind impeller and become loose as impeller is removed.

4. The seal head can now be pulled from shaft.
5. (For Cast Iron Units) Remove fasteners (Ref. No. 4) holding adapter (Ref. No. 2) to motor (Ref. No. 1). Remove adapter from motor shaft. (For SS Units) Remove seal plate (Ref. No. 3) from adapter.
6. Pry seal seat from adapter.

### INSTALLATION OF NEW SEAL

#### ▲ CAUTION

*The precision lapped faces on mechanical seal are easily damaged. Handle your repair seal carefully. Do not touch polished seal faces.*

**IMPORTANT:** Be sure that shaft shoulder does not damage polished faces.

1. Thoroughly clean all surfaces of seal seat cavity in adapter or seal plate.
2. Using a clean cloth, wipe shaft and make certain that it is perfectly clean.
3. Wet the rubber portion of new seal seat with a light coating of soapy water. While wearing clean gloves or using a clean rag, press seal seat squarely into adapter seal plate recess. Use cardboard washer (usually supplied with new seal), place over polished surface and use a piece of pipe or dowel rod to press in firmly but gently. Avoid scratching polished face.
4. Dispose of cardboard washer. Check again to see that polished face is free of dirt and all other foreign particles and that it has not been scratched or damaged. (Cast iron unit) Replace adapter on motor with four fasteners, (SS unit) replace seal plate into adapter cavity.
5. Wet the inside rubber portion of new seal head with a light coating of soapy water. Slide head onto motor shaft with sealing surface facing seal seat (see figure 1).

**Note:** A short "run in" period may be necessary to provide completely leak-free operation.

6. Screw impeller onto shaft. Make sure to replace all shims. Use screwdriver slot at rear of motor shaft (opposite the threaded end) to tighten impeller.

# Centrifugal Pumps

**NOTE:** It may be necessary to remove plug in motor end cap to expose slot. If removed, be sure to reinstall plug AFTER pump is completely assembled.

7. Check if shaft turns freely by spinning impeller. If rubbing or binding is found, remove impeller and add a shim to shaft, then recheck. Repeat procedure until all rubbing is eliminated.
8. Screw impeller lock nut onto shaft and tighten.
9. Place casing seal on adapter mounting flange. Attach casing using bolts being careful not to pinch or "shave" casing seal. As casing is being tightened, periodically spin impeller to check for interference with casing. If rubbing or binding is found remove casing and impeller. Remove a shim from between impeller and motor shaft shoulder. Repeat procedure until no rubbing is encountered.

## **⚠ CAUTION**

*Seal will produce minor drag when spinning motor shaft, but rubbing anywhere else must be eliminated! Otherwise, damage to pump and/or motor may occur.*

## **CLEANING IMPELLER**

Pumps are equipped with a two-piece impeller assembly that can be taken apart to clean or remove debris from passages.

1. Remove casing from adapter exposing impeller assembly.
2. Put a mark across the front shroud (Ref. No. 6) edge and an impeller (Ref. No. 5) vane tip to mark orientation.
3. Using a 3mm hex wrench remove four screws (Ref. No. 7) holding impeller front shroud to impeller.
4. Remove front shroud plate.
5. Remove any trapped solids or debris from impeller passages.
6. Align rotation of front shroud with impeller using mark from step 2. Install front shroud with four screws, install casing.

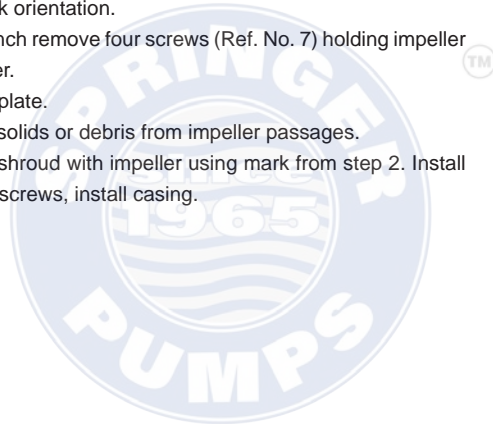

# Centrifugal Pumps

**For Repair Parts contact dealer where pump was purchased.**

Please provide following information:

-Model Number

-Serial Number (if any)

Part description and number as shown in parts list

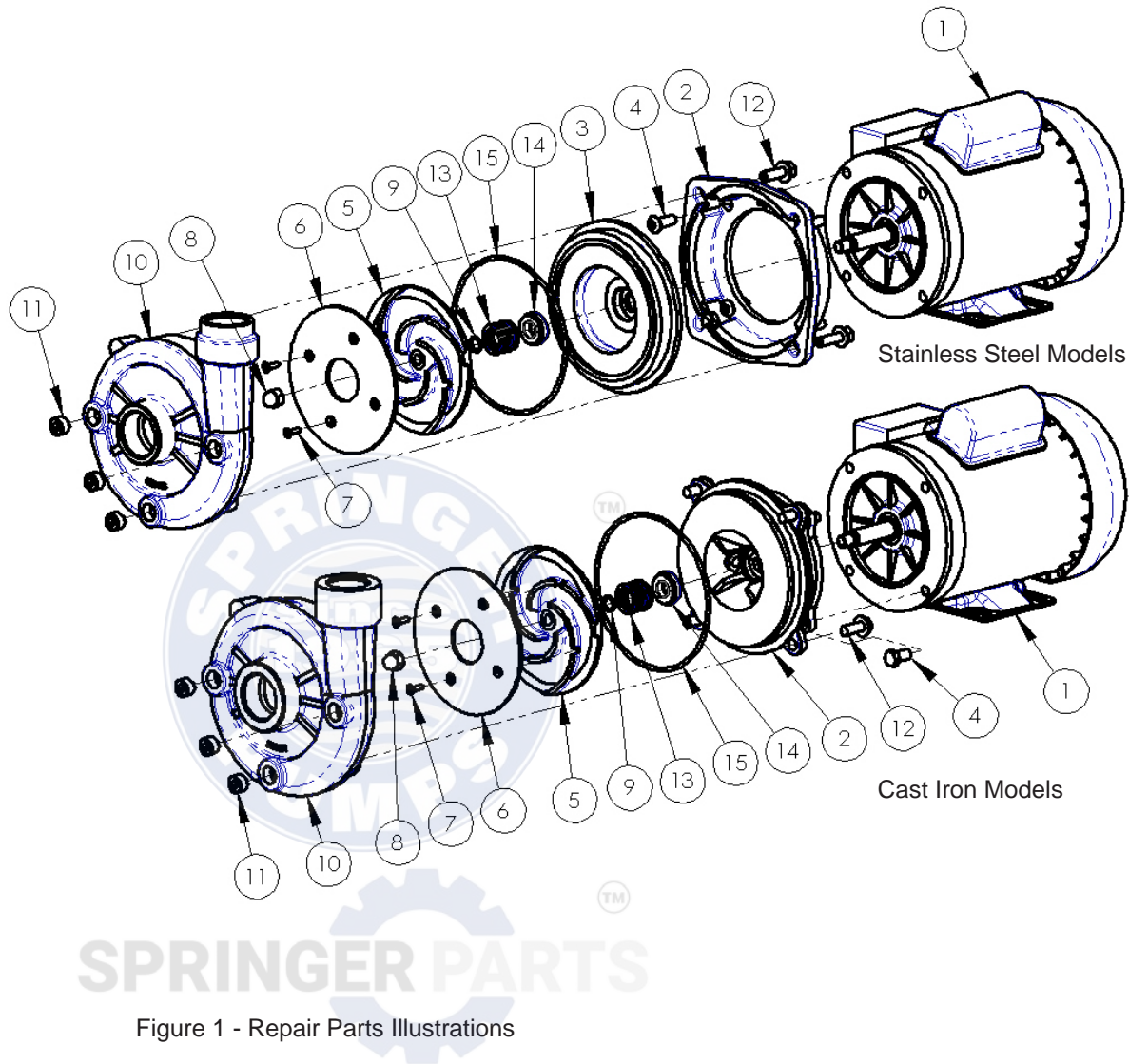
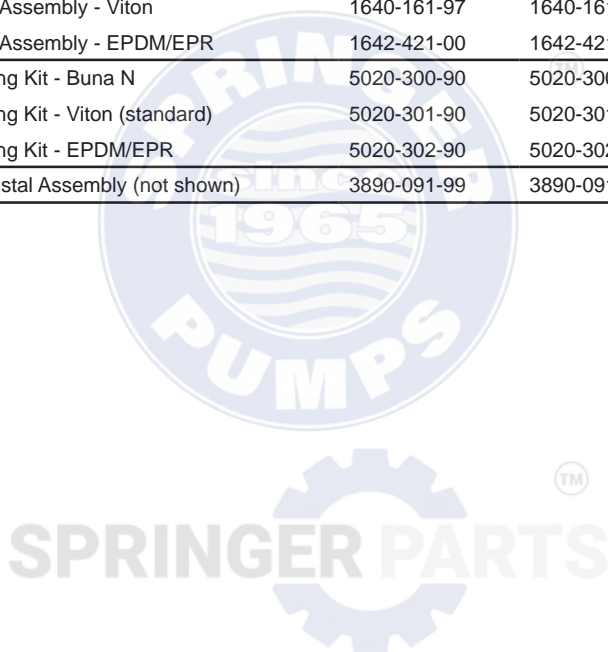

Figure 1 - Repair Parts Illustrations

**Repair Parts List - Cast Iron Models**

Ref No.	Description	Part Number for Models				Qty
		5020-95 5021-95	5022-95 5023-95	5030-95 5031-95	5032-95 5033-95	
1	Motor - 1 PH TEFC	1626-304-00	1626-303-00	1626-306-00	1626-305-00	1
	Motor - 3 PH TEFC	1627-310-00	1627-309-00	1627-312-00	1627-311-00	1
2	Adapter Kit (includes Ref. Nos. 2, 3 and 4)	5020-030-95	5020-030-95	5030-030-95	5030-030-95	1
3	Seal Plate	N/A	N/A	N/A	N/A	1
4	3/8-16 Hex Screw	Incl. w/Ref 2	Incl. w/Ref 2	Incl. w/Ref 2	Incl. w/Ref 2	4
5	Impeller Kit (includes Ref. Nos. 5, 6, 7, 8 and 9)	5020-010-98	5022-010-98	5030-010-98	5032-010-98	1
6	Impeller Shroud	Incl. w/Ref 5	Incl. w/Ref 5	Incl. w/Ref 5	Incl. w/Ref 5	1
7	Impeller Shroud Screw	Incl. w/Ref 5	Incl. w/Ref 5	Incl. w/Ref 5	Incl. w/Ref 5	4
8	Impeller Lock Nut	Incl. w/Ref 5	Incl. w/Ref 5	Incl. w/Ref 5	Incl. w/Ref 5	1
9	Impeller Shims	Incl. w/Ref 5	Incl. w/Ref 5	Incl. w/Ref 5	Incl. w/Ref 5	2
10	Casing Kit (includes Ref. Nos. 10, 11 and 12)	5020-001-95	5020-001-95	5030-001-95	5030-001-95	1
11	3/8" NPT Plug	Incl. w/Ref 10	Incl. w/Ref 10	Incl. w/Ref 10	Incl. w/Ref 10	3
12	3/8-16 Hex Screw	Incl. w/Ref 10	Incl. w/Ref 10	Incl. w/Ref 10	Incl. w/Ref 10	4
13 & 14	Seal Assembly - Viton Sic/Sic (standard)	1640-165-90	1640-165-90	1640-165-90	1640-165-90	1
	Seal Assembly - Buna-N	1640-161-96	1640-161-96	1640-161-96	1640-161-96	1
	Seal Assembly - Viton	1640-161-97	1640-161-97	1640-161-97	1640-161-97	1
	Seal Assembly - EPDM/EPR	1642-421-00	1642-421-00	1642-421-00	1642-421-00	1
KIT	O-Ring Kit - Buna N	5020-300-90	5020-300-90	5030-300-90	5030-300-90	1
	O-Ring Kit - Viton (standard)	5020-301-90	5020-301-90	5030-301-90	5030-301-90	1
	O-Ring Kit - EPDM/EPR	5020-302-90	5020-302-90	5030-302-90	5030-302-90	1
NS	Pedestal Assembly (not shown)	3890-091-99	3890-091-99	3890-091-99	3890-091-99	1



## Repair Parts List - Stainless Models

Ref No.	Description	Part Number for Models				Qty
		5020-98 5021-98	5022-98 5023-98	5030-98 5031-98	5032-98 5033-98	
1	Motor - 1 PH TEFC	1626-304-00	1626-303-00	1626-306-00	1626-305-00	1
	Motor - 3 PH TEFC	1627-310-00	1627-309-00	1627-312-00	1627-311-00	1
2	Adapter Kit (includes Ref. Nos. 2, 3 and 4)	5020-030-98	5020-030-98	5030-030-98	5030-030-98	1
3	Seal Plate	Incl. w/Ref 2	Incl. w/Ref 2	Incl. w/Ref 2	Incl. w/Ref 2	1
4	3/8-16 Button Head Screw	Incl. w/Ref 2	Incl. w/Ref 2	Incl. w/Ref 2	Incl. w/Ref 2	4
5	Impeller Kit (includes Ref. Nos. 5, 6, 7, 8 and 9)	5020-010-98	5022-010-98	5030-010-98	5032-010-98	1
6	Impeller Shroud	Incl. w/Ref 5	Incl. w/Ref 5	Incl. w/Ref 5	Incl. w/Ref 5	1
7	Impeller Shroud Screw	Incl. w/Ref 5	Incl. w/Ref 5	Incl. w/Ref 5	Incl. w/Ref 5	4
8	Impeller Lock Nut	Incl. w/Ref 5	Incl. w/Ref 5	Incl. w/Ref 5	Incl. w/Ref 5	1
9	Impeller Shims	Incl. w/Ref 5	Incl. w/Ref 5	Incl. w/Ref 5	Incl. w/Ref 5	2
10	Casing Kit (includes Ref. Nos. 10, 11 and 12)	5020-002-98	5020-002-98	5030-002-98	5030-002-98	1
11	3/8" NPT Plug	Incl. w/Ref 10	Incl. w/Ref 10	Incl. w/Ref 10	Incl. w/Ref 10	3
12	3/8-16 Button Head Screw	Incl. w/Ref 10	Incl. w/Ref 10	Incl. w/Ref 10	Incl. w/Ref 10	4
13 & 14	Seal Assembly - Viton Sic/Sic (standard)	1640-165-90	1640-165-90	1640-165-90	1640-165-90	1
	Seal Assembly - Buna-N	1640-161-96	1640-161-96	1640-161-96	1640-161-96	1
	Seal Assembly - Viton	1640-161-97	1640-161-97	1640-161-97	1640-161-97	1
	Seal Assembly - EPDM/EPR	1642-421-00	1642-421-00	1642-421-00	1642-421-00	1
KIT	O-Ring Kit - Buna N	5020-300-90	5020-300-90	5030-300-90	5030-300-90	1
	O-Ring Kit - Viton (standard)	5020-301-90	5020-301-90	5030-301-90	5030-301-90	1
	O-Ring Kit - EPDM/EPR	5020-302-90	5020-302-90	5030-302-90	5030-302-90	1
NS	Pedestal Assembly (not shown)	3890-091-99	3890-091-99	3890-091-99	3890-091-99	1

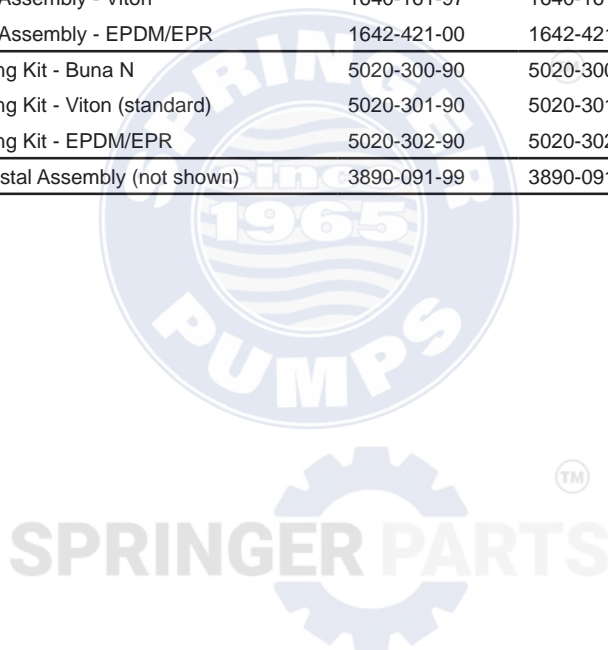

**NOTES:**

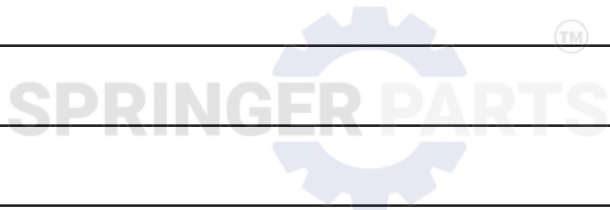
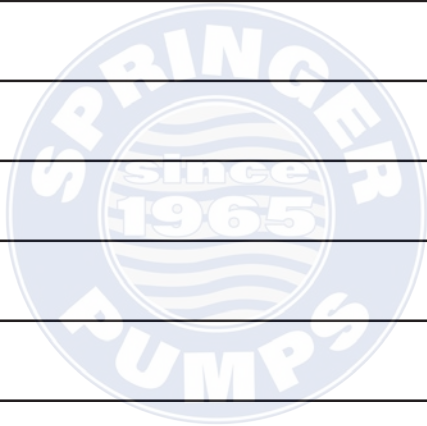



AMT Pump Company  
(herein "AMT")  
400 Spring Street  
Royersford, PA 19468  
Phone: (610) 948-3800  
Fax: (610) 948-5300  
www.amtpump.com

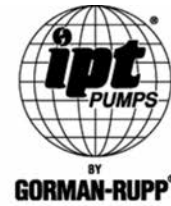

## General Information

**SALES POLICY:** AMT products are sold through our established Distributors. We do not sell direct to the consumer or organization not entitled to trade recognition. Therefore, possession of our catalogs and/or price list(s) does not infer an offer to sell.

**MINIMUM ORDER:** We appreciate your order, however, all orders are subject to a minimum \$35.00 net invoice charge (excluding freight). This applies to all pump and parts purchase orders.

**PRICES:** Prices are subject to change without notice. All orders accepted are subject to prices in effect at time of shipment.

**PAYMENT TERMS:** Terms, upon establishment of credit, are Net 30 days. Past due accounts may be subject to a service charge of 1.5% per month. Domestic or assignable letter of credit is required for all export trade.

**PAST DUE ACCOUNTS:** AMT reserves the right to withhold open account shipments on any past due account. Invoices are considered past due after thirty (30) days. In the interest of sound business, all orders are subject to approval of the Credit Department.

**SHIPPING INSTRUCTIONS:** All shipments will be made F.O.B. the factory. Where instructions for shipment do not appear on the order, the shipment will be made according to our best judgment. Full risk of loss (including transportation delays and losses) shall pass to the customer upon delivery of the products to the carrier at the F.O.B. point. When loss or delay occurs, primary responsibility for tracing rests with the customer. When there is LOSS or APPARENT VISIBLE DAMAGE to a shipment, when tendered for delivery, **DO NOT** give the carrier a clear receipt. Note such damage on the carrier's delivery receipt and **HAVE THE DRIVER SIGN THE RECEIPT.**

**PRODUCT REVISIONS:** AMT reserves the right to discontinue, change or improve its products or any portions thereof without being obligated to provide such a change or improvement for units sold and/or shipped prior to such a change or improvement.

**LEAD TIME:** Products designated "Quick Ship Product", also referred to as "QSP" will normally be shipped within 24 hours of receipt of a non-cancellable purchase order. Only limited quantities of "QSP" pumps are available.

**STANDARD LEAD TIME:** Lead time is two weeks for all non "QSP" product. AMT reserves the right to revise lead times as required due to availability of materials and all other causes beyond our control.

**VIP SHIPMENT:** Select AMT and IPT branded pumps are available for next day shipment for non-QSP (Quick Ship Products) items and subjected to a specific model surcharge per unit noted in the respective price book. Requires calling for availability, confirmation and a non-cancellable purchase order or credit card payment prior to shipment. The expedited shipping charges are an additional cost added separately from the VIP charges per item. AMT reserves the right to revise lead times as required due to availability of materials and all other causes beyond our control. QSP quantities are limited as determined by AMT.

ALL purchase orders must be submitted via hard copy sent to AMT customer service department by fax, EDI or e-mail.

**RETURN GOODS POLICY:** Goods shall not be returned without a return goods authorization number (RGA) issued by AMT customer service. The RGA number must be listed on the packing list. Only current model and part numbers with a valid date code may be returned (within one year from date of purchase). **A 20% restocking and packaging charge will apply to all returns. All shipping charges must be pre-paid. No exceptions.**

**ORDER CHANGES BY CUSTOMER:** Orders in process may not be changed except with written consent and may be subject to special charges.

## 12 Month Limited Warranty

### EXTENT AND DURATION OF LIMITED WARRANTY

**Coverage:** AMT Pump Company (herein "AMT") or IPT Pumps by Gorman-Rupp (herein "IPT") or Gorman-Rupp Industries Division of the The Gorman-Rupp Company, Patterson, or the Gorman-Rupp Company (herein referred to as "G-R Unit") each individually warrants that its products and parts shall be free from defects in material and workmanship for twelve (12) months from the date of purchase by the original end user when installation is made and maintenance is performed in accordance with G-R Unit's recommendations. Wear and tear resulting from use and items normally consumed in use are not covered.

### EXCEPTIONS

( A ) This Limited Warranty shall not apply to mechanical seals in AMT or IPT pumps and the following products and parts: engines, motors, trade accessories and all other products, components, parts and materials not manufactured by the G-R Units. These items may, however, be covered by the warranties of their respective manufacturers. ( B ) This warranty does not extend to or apply to any unit which has been repaired or altered at any place other than by a G-R Unit, or by persons not expressly approved by a G-R Unit to make repairs or alterations, nor to any unit the serial number, model number or identification of which has been removed, defaced or altered. ( C ) This warranty does not extend to any product manufactured by a G-R Unit, which has been subjected to mis-use, neglect, accident, improper installation, or use in violation of instructions furnished by a G-R Unit. ( D ) Pump Kits: This warranty does not extend to any product sold by a G-R Unit unassembled as a Pump Kit. Pump Kits are warranted against defects in material and workmanship for 60 days from the date of shipment from a G-R Unit. Any Pump Kit parts deemed defective by a G-R Unit will be replaced free of charge within 60 days of shipment. Pump Kits are not returnable for credit.

### LIMITATIONS

**THE G-R UNITS' SOLE AND EXCLUSIVE WARRANTY WITH RESPECT TO THEIR PRODUCTS AND PARTS IS THIS LIMITED WARRANTY. THIS LIMITED WARRANTY IS IN LIEU OF ALL OTHER EXPRESS AND/OR IMPLIED WARRANTIES, INCLUDING IMPLIED WARRANTIES OF MERCHANTABILITY AND FITNESS FOR PARTICULAR PURPOSE.**

### EXCLUSIVE REMEDY AND DAMAGES

The sole and exclusive remedy for breach of this Warranty by a G-R Unit and the entire extent of its liability for such breach or for damages arising from the use of the products and parts covered under this Limited Warranty, shall be as follows:

- Repair or Replacement:** If inspection shows that any G-R Unit product or part covered under this Limited Warranty is defective in materials or workmanship, the G-R Unit shall repair or replace the defective or non-conforming product or part without charge, whichever the G-R Unit chooses. You must have properly maintained and used the product or part claimed to be defective in accordance with the maintenance schedule or manual, which comes with the product. No allowance will be made for labor, installation, removal, transportation or other charges incurred by you in connection with such repair or replacement.
- To obtain the above remedy:

  - Immediately notify the G-R Unit upon discovery of the claimed defect in materials or workmanship and provide the serial number or date code of the product and/or part(s) or provide the G-R Unit with the invoice or bill of sale referencing the product by no later than the expiration date of the warranty period.
  - The G-R Unit will advise whether inspection will be necessary and how whether repair or replacement will be made. If inspection by the G-R Unit is necessary, the pump or defective part must be sent freight pre-paid to the G-R Unit. Return shipment will be F.O.B. the G-R Unit's plant.
  - Return Goods Authorization Requirement:** No product will be accepted for return or replacement without the prior written authorization of the G-R Unit. Upon such authorization, and in accordance with instructions from the G-R Unit, the product will be returned to the G-R Unit, shipping charges prepaid by the Buyer.
- Damages:** The G-R Unit's liability for damages for breach of this Limited Warranty shall not exceed the amount of the purchase price of the product or part(s) in respect to which Such damages are claimed. **IN NO EVENT SHALL THE G-R UNITS BE LIABLE FOR INCIDENTAL, CONSEQUENTIAL OR SPECIAL DAMAGES FOR BREACH OF THIS LIMITED WARRANTY.**

Some states do not allow the exclusion or limitation of incidental or consequential damages, so the above limitation or exclusion may not apply to you. This Limited Warranty gives you specific legal rights, and you may also have other rights, which vary from state to state.

AMT Pump Company, A Gorman-Rupp Company, 400 Spring Street, Royersford, PA 19468 USA



**A Gorman-Rupp Company**



BY  
**GORMAN-RUPP®**

[www.amtpump.com](http://www.amtpump.com)